

BODY ENCLOSURE

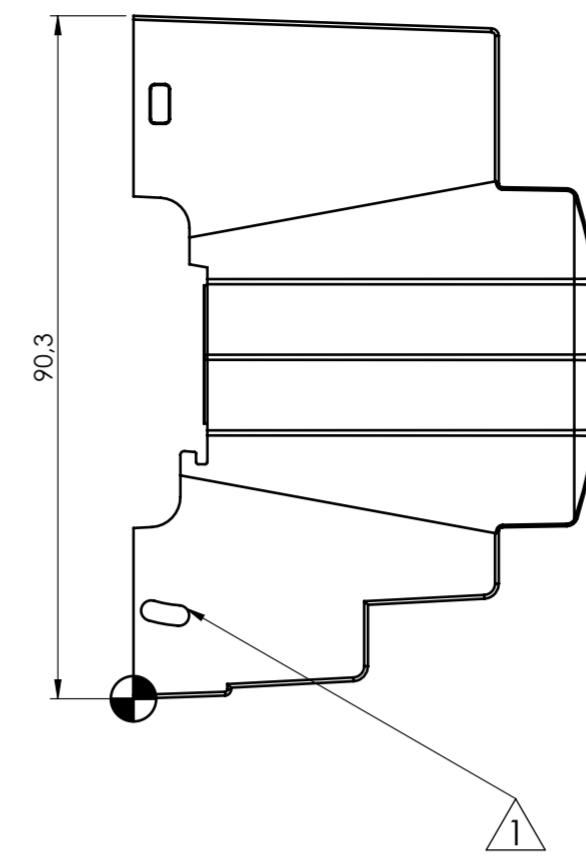

BASE

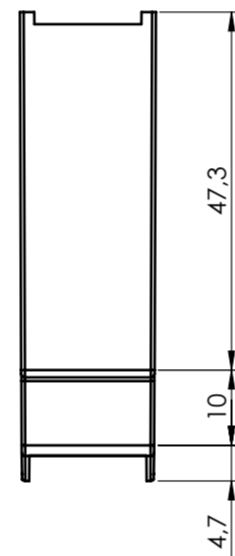
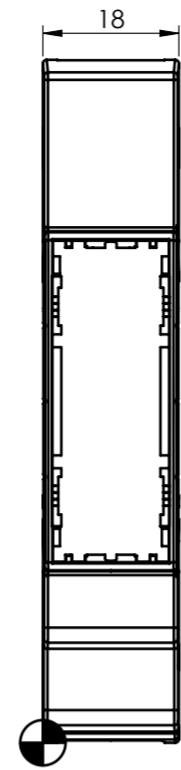
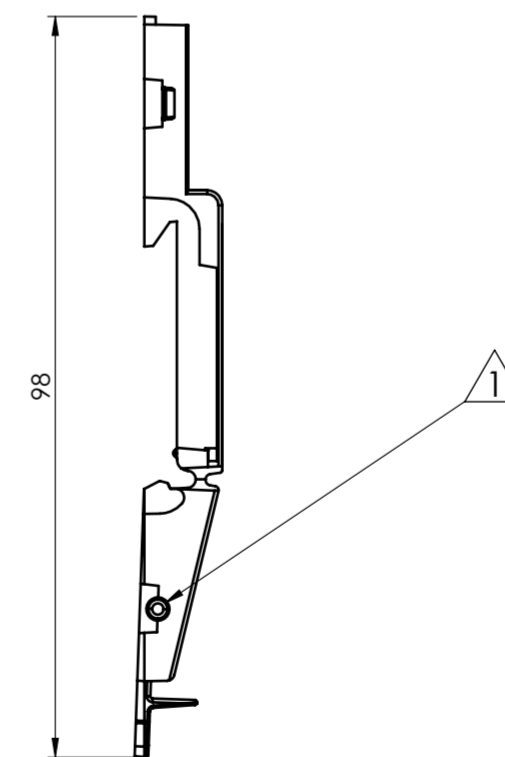
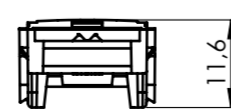
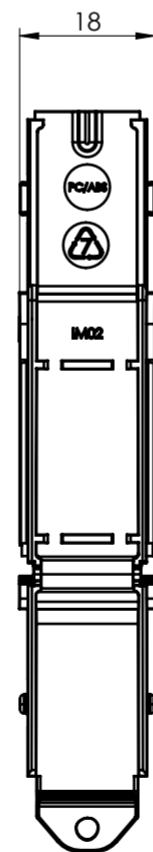

General information:
 - Workpiece zero point for mechanical processing
 - Minimum recommended radius for machining = R1.0 mm
 - Mounting rail like EN 60715: TH 35-7.5 or TH 35-15
 - Recommended PCB outline on www.italtronic.com

Revisions			
Rev.	Description	Date	Mod. by
1	Modificato il sistema di aggancio della base.	13/06/2024	M.S.

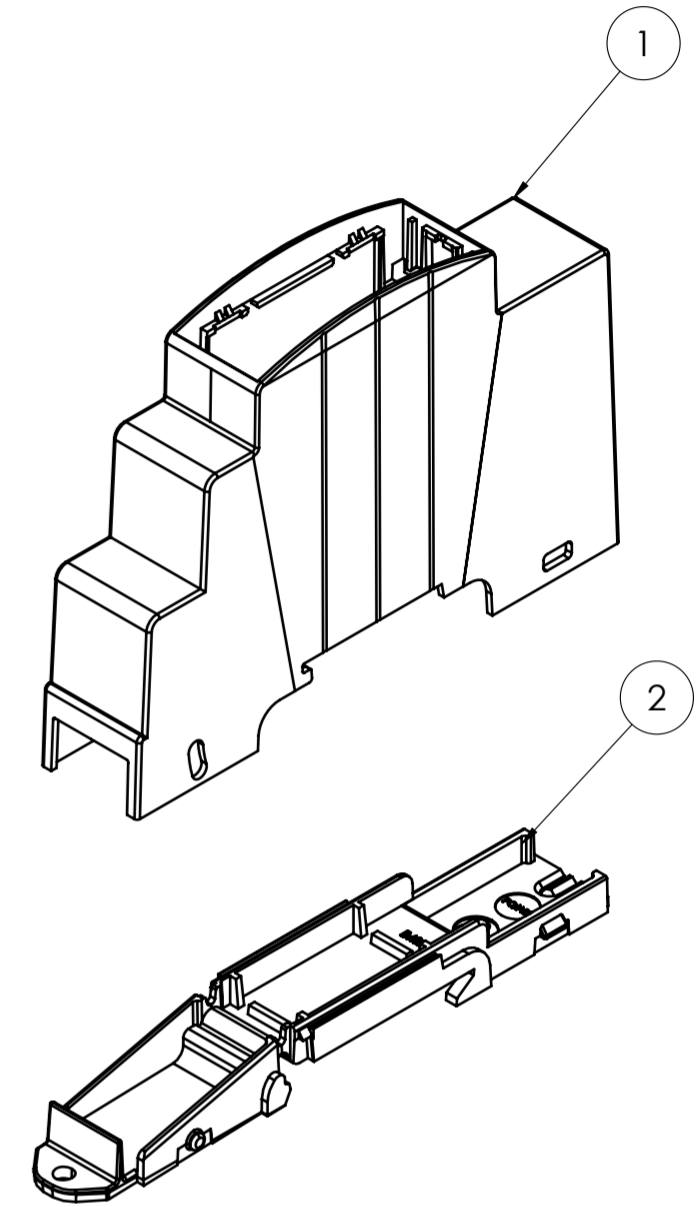

RIF.	Q.TY	DRAWING	DESCRIPTION
1	1	2_250_00169	BODY ENCLOSURE MODULBOX XTS 1M53-B
2	1	2_250_00092	BASE MODULBOX XTS 1M

General Tolerance UNI EN 22768/1 Media (m)						Sheet:
from 0.5 to 3 ± 0.1	from 3 to 6 ± 0.1	from 6 to 30 ± 0.2	from 30 to 120 ± 0.3	from 120 to 400 ± 0.5		1
Scale:	IM:	Drawn:	Checked:	Date:	Material:	Process:
1:1	--	M.S.	R.N.	17/07/2023		
Dimension in mm		Replaces the:		Derived from:	Weight:	Cod. Mold:
		M-06129-00		--	gr	--

		Description:		Rev.:
italtronic.com		KIT CONTENITORE MODULBOX XTS 1M53-B KIT ENCLOSURE MODULBOX XTS 1M53-B		01
		Drawing nr.:		A2
		3_250_00142		

PCB A

PCB C

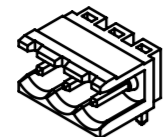
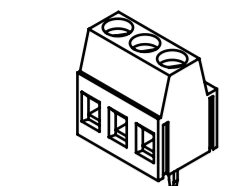

Ass.El. MV253-5_08-V

Ass.El. PV03-5_08-H

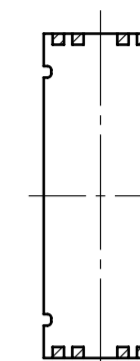
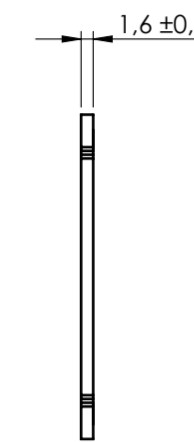
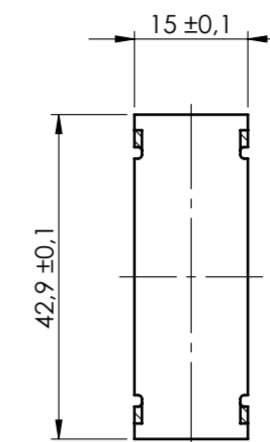
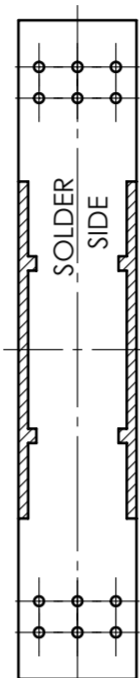
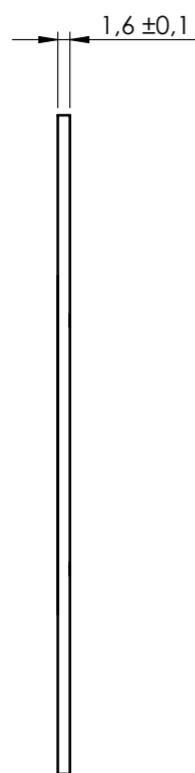
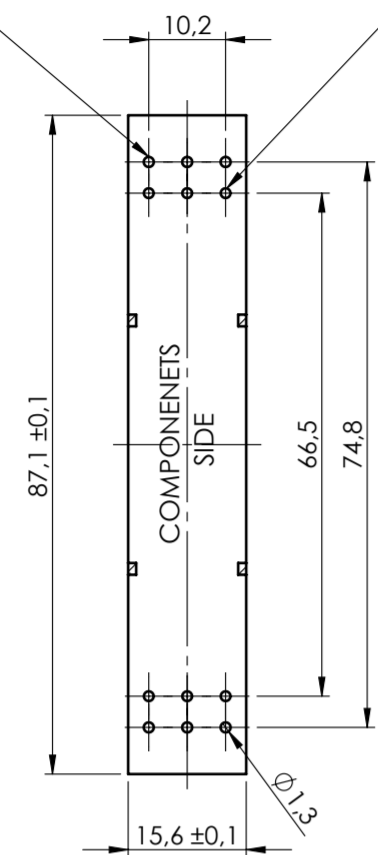

PCB V

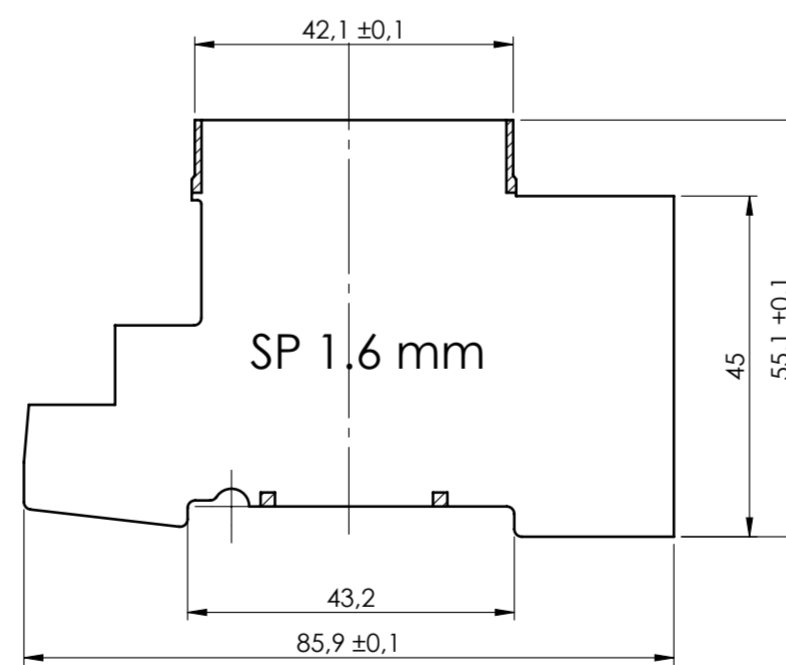

General Tolerance UNI EN 22768/1 Media (m)					Sheet:
from 0.5 to 3 ± 0.1	from 3 to 6 ± 0.1	from 6 to 30 ± 0.2	from 30 to 120 ± 0.3	from 120 to 400 ± 0.5	PCB
Scale: 1:1	IM: --	Drawn: M.S.	Checked: R.N.	Date: 17/07/2023	Process:
Dimension in mm		Replaces the: M-06129-00	Derived from: --	Weight: gr	Cod. Mold: --
 enclosures for electronics italtronic.com		Description: KIT CONTENITORE MODULBOX XTS 1MS3-B KIT ENCLOSURE MODULBOX XTS 1MS3-B			Rev.: 01
		Drawing nr.: 3_250_00142			A2

NO COMPONENTS AREA